

J. H. & A. T. KIEGL.
TERMINAL CONNECTOR FOR ELECTRICAL CONDUCTORS.
APPLICATION FILED DEC. 8, 1904.

Fig. 1

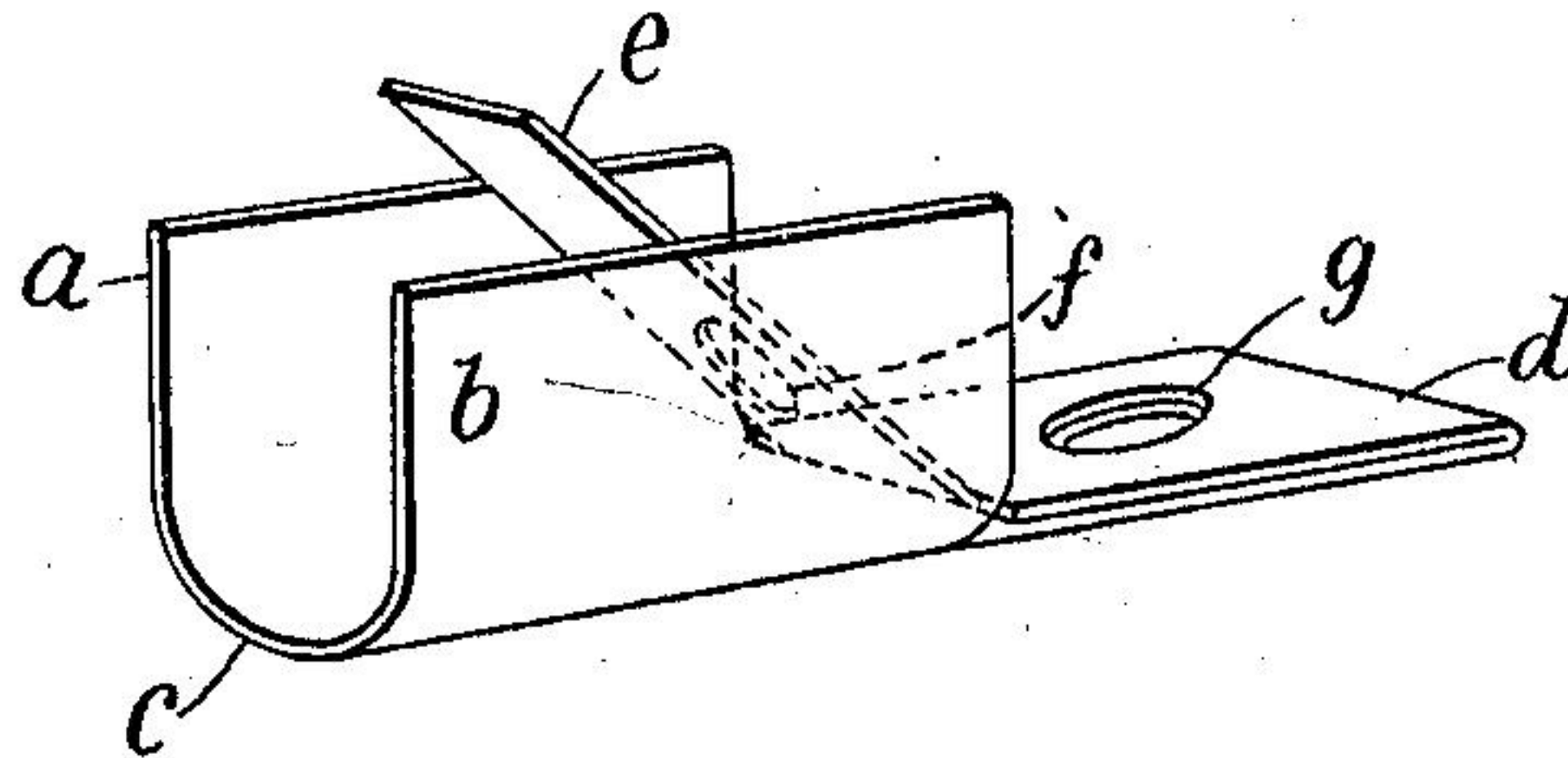

Fig. 2

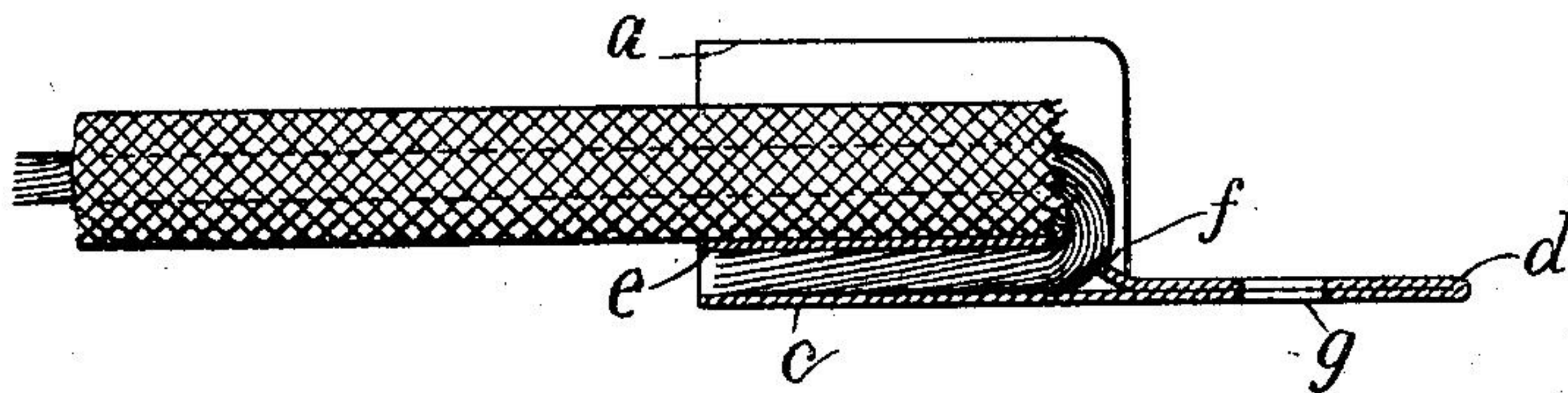

Fig. 3

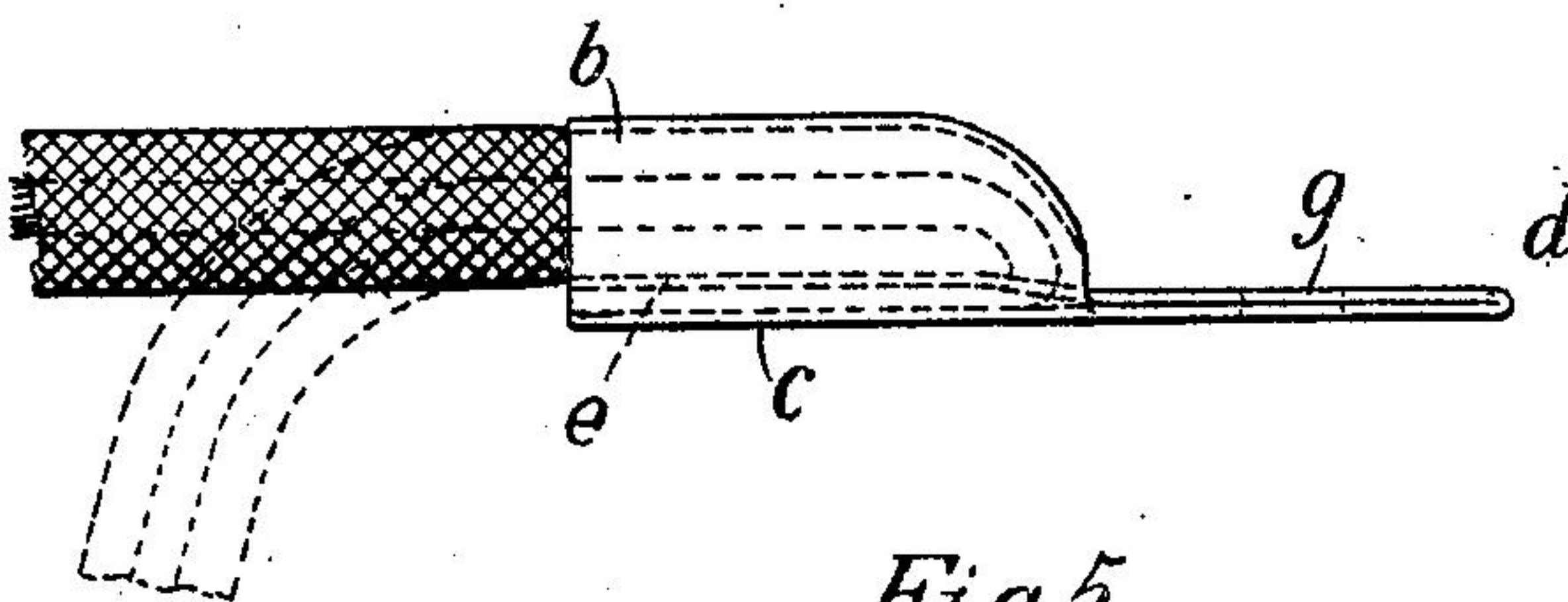

Fig. 4

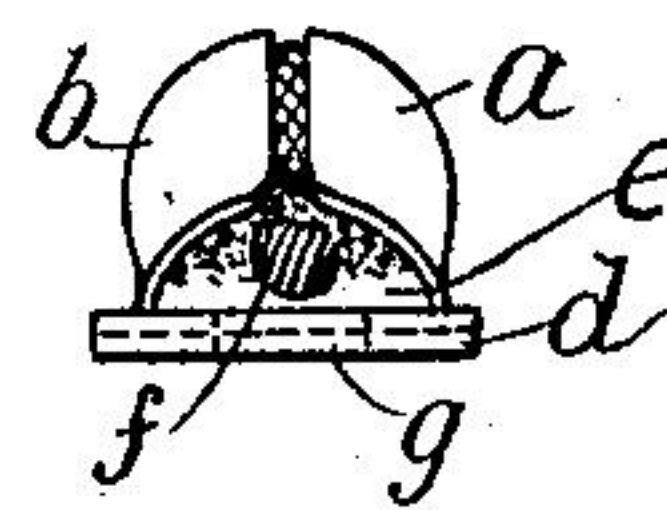

Fig. 5

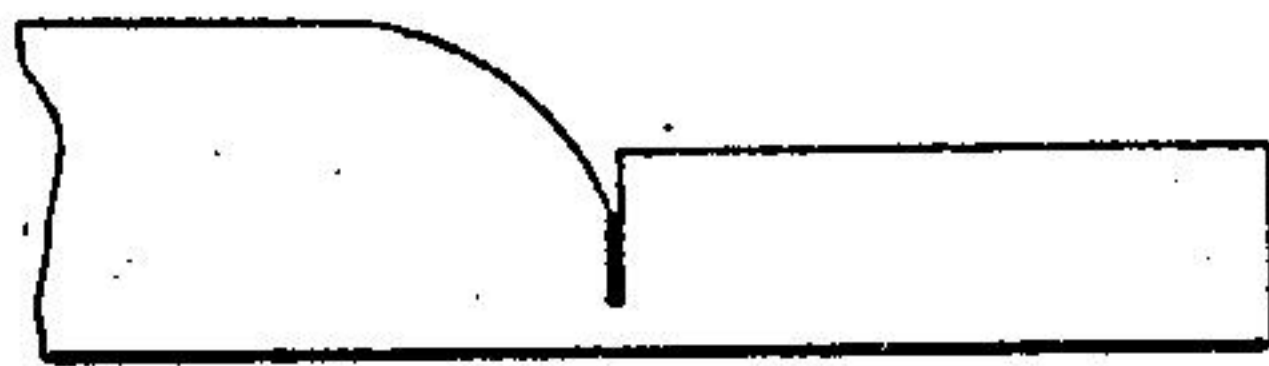

Fig. 6

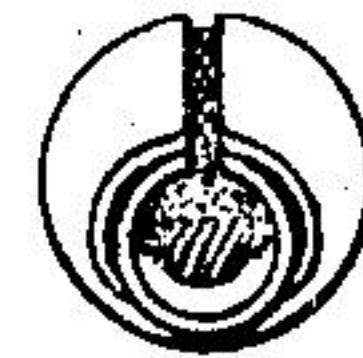
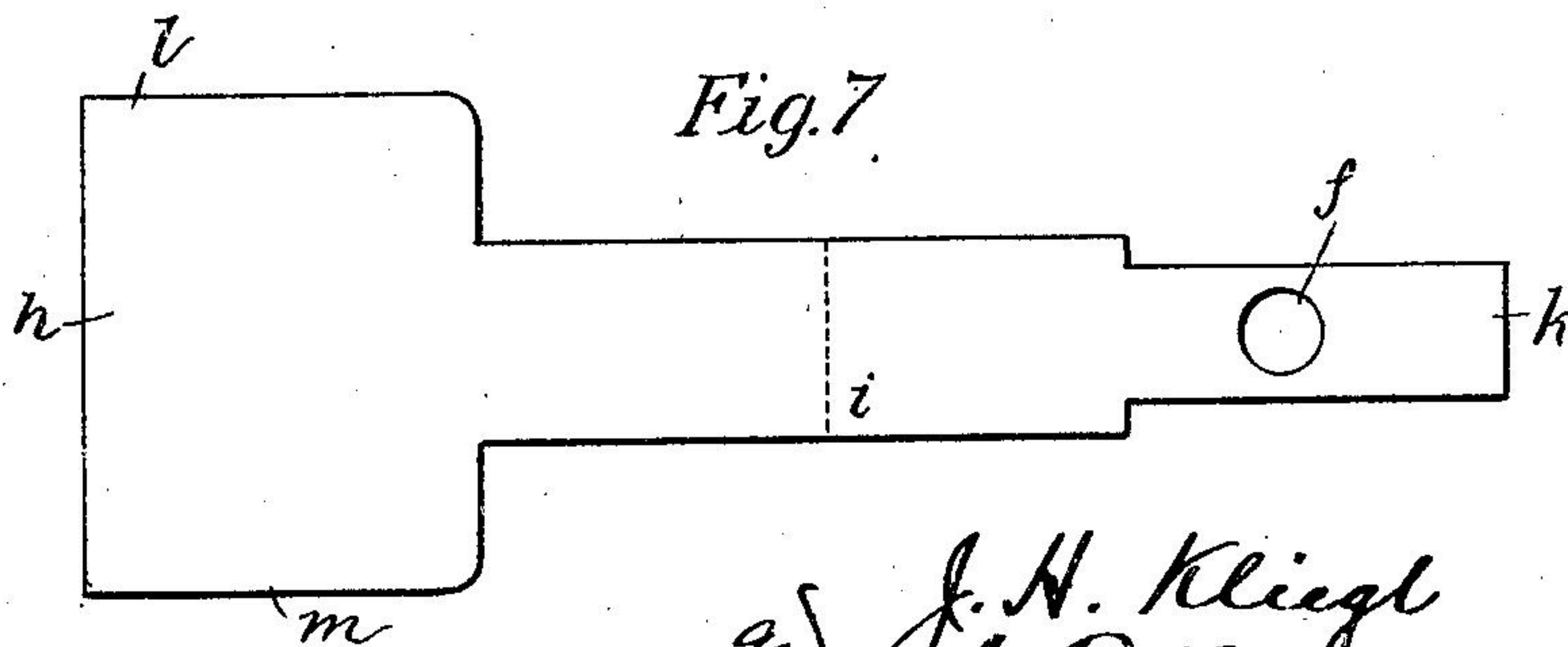

Fig. 7



Witnesses
Thos. J. Byrnes
A. L. Dunham,

and J. H. Kiegl
A. T. Kiegl Inventors,
By their Attorneys
Kerr, Page & Cooper